

Quick Start Guide FE-170/X-760

Start Here

For more information, please refer to the Basic & Advanced Manuals or visit: www.olympusamerica.com/support

OLYMPUS IMAGING AMERICA INC.

© 2006 OLYMPUS IMAGING CORP.
Printed in China

VH752301

1 Gather these items (box contents)

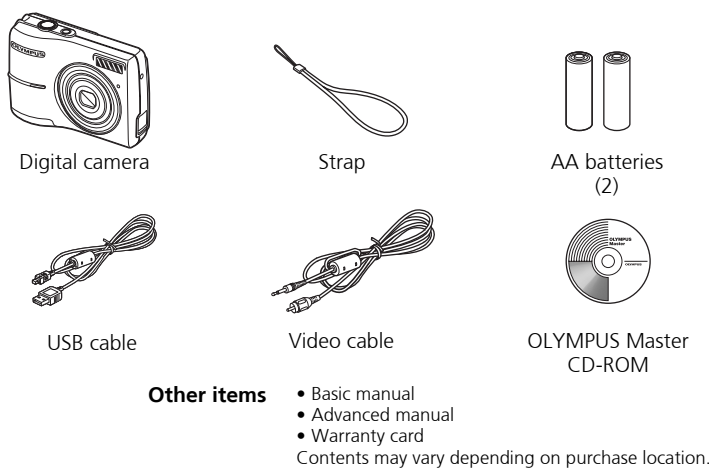

Attach the strap

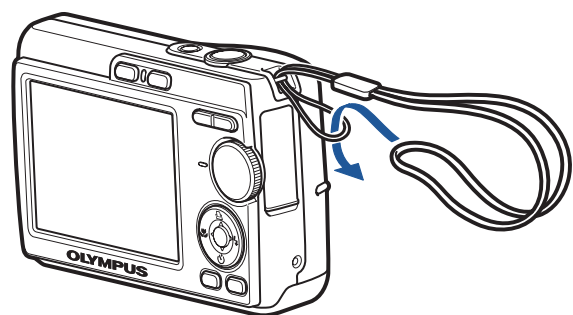

• Pull the strap tight so that it does not come loose.

2 Insert the batteries

a. Insert the batteries into the camera

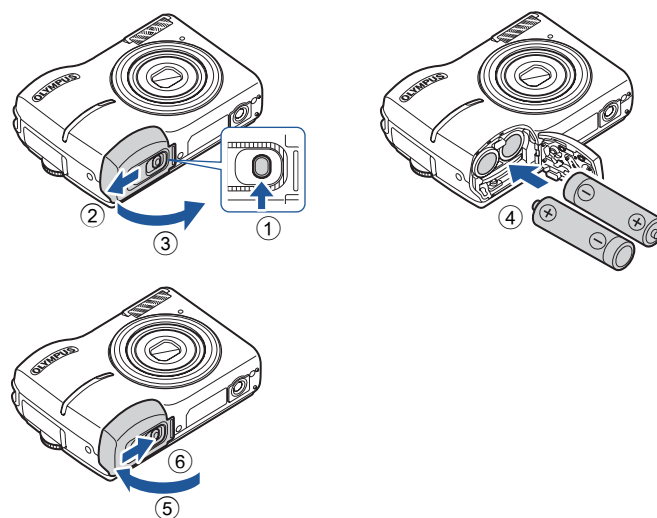

• For details on inserting an optional xD-Picture Card, please refer to Advanced Manual.

3 Turn on the power

This section explains how to turn on the camera in shooting mode.

a. Set the mode dial to **AUTO**

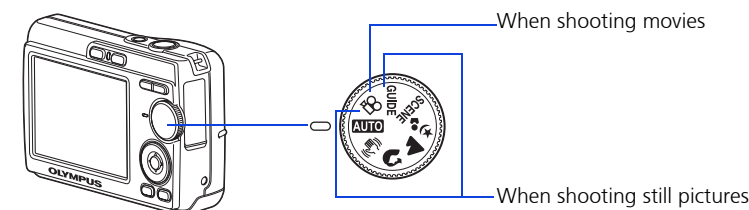

Still picture shooting modes

AUTO	The camera determines the optimum settings and shoots the picture.
	This function reduces the blur caused by a moving subject or camera movement when taking pictures.
	Suitable for taking pictures of people.
	Suitable for taking pictures of landscapes.
	Suitable for taking pictures of people at night.
SCENE	Shoot pictures by selecting a scene mode according to the situation.
GUIDE	You can set the items you want by doing the settings according to the shooting guide displayed on the screen.

b. Press the **POWER** button

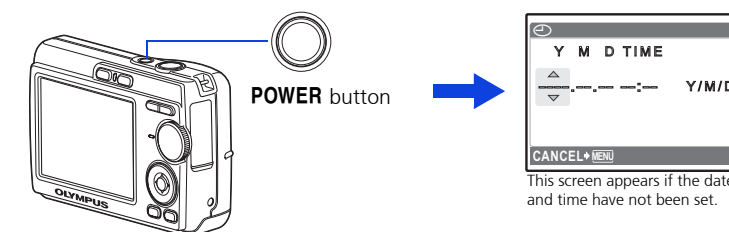

• To turn off the camera, press the **POWER** button again.

4 Set date and time

About the date and time setting screen

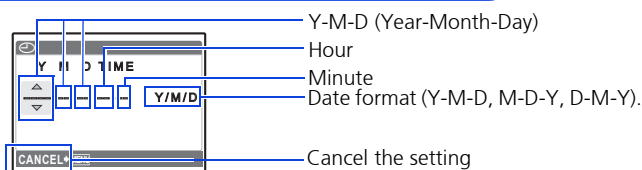

a. Press the Δ button and ∇ button to select [Y].
• The first two digits of the year are fixed.

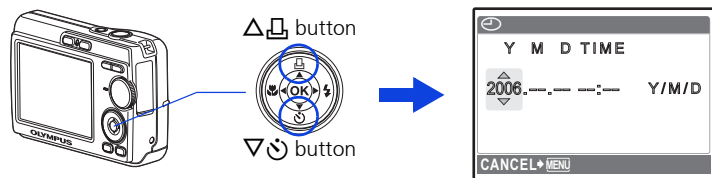

b. Press the \triangleright button.

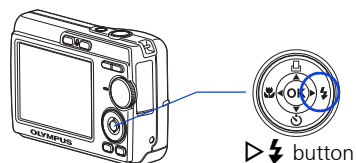

c. Press the Δ button and the ∇ button to select [M].

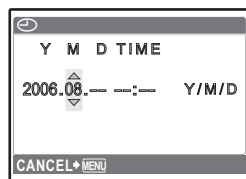

d. Press the \triangleright button.

e. Press the Δ button and the ∇ button to select [D].

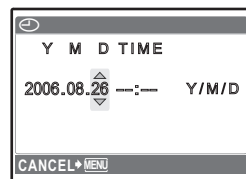

f. Press the \triangleright button.

g. Press the Δ button and the ∇ button to select "hour" and "minute".

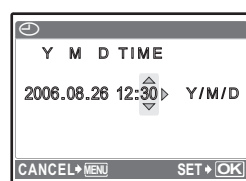

h. Press the \triangleright button.

i. Press the Δ button and ∇ button to select year, month and date.

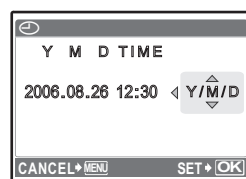

j. After all items have been set, press \odot .

• The time is displayed in the 24-hour format.
• For a more accurate setting, you can press \odot when the time signal hits 00 seconds.

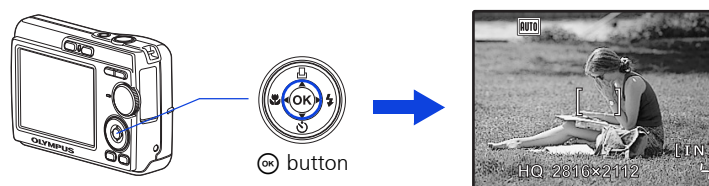

5 Shoot

a. Hold the camera

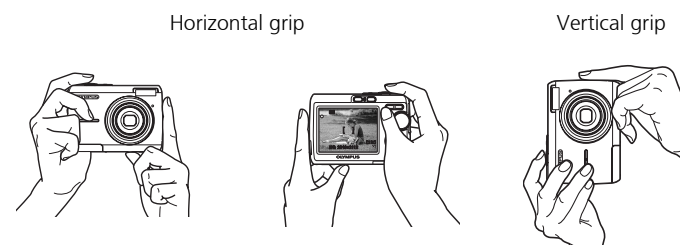

b. Focus

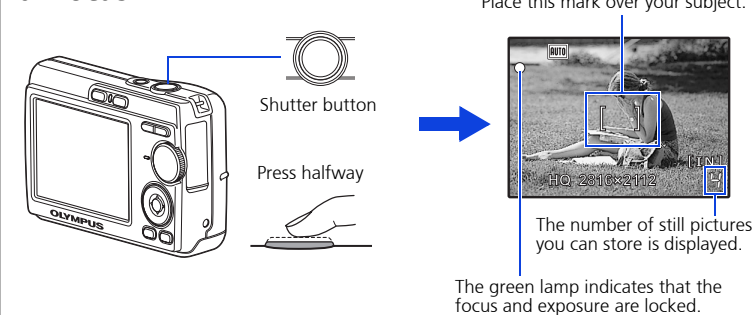

c. Shoot

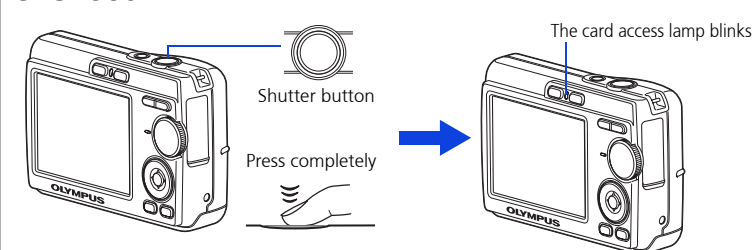

6 View pictures

a. Press the \triangleright button.

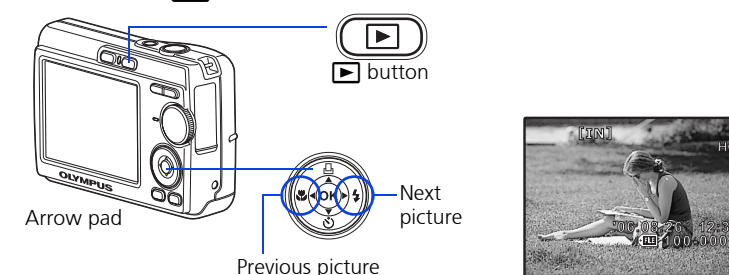

Erase pictures

a. As described in a. above, display the picture you want to erase
b. Press the trash button.

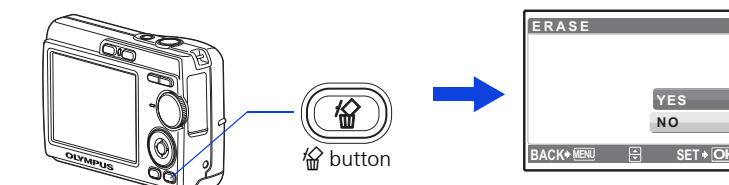

c. Press the Δ button to select [YES] and press \odot .

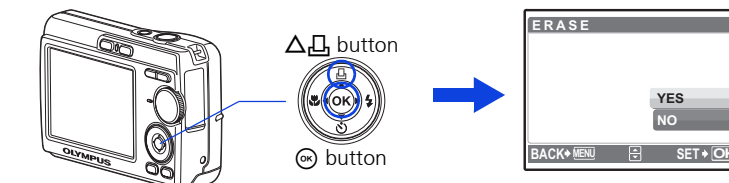

Guia de iniciação rápida FE-170/X-760

Começar aqui

Para maiores informações, consulte os Manuais Básico e Avançado ou visite a página web: www.olympusamerica.com/support

OLYMPUS IMAGING AMERICA INC.

1 Reúna estes itens (conteúdo da caixa)

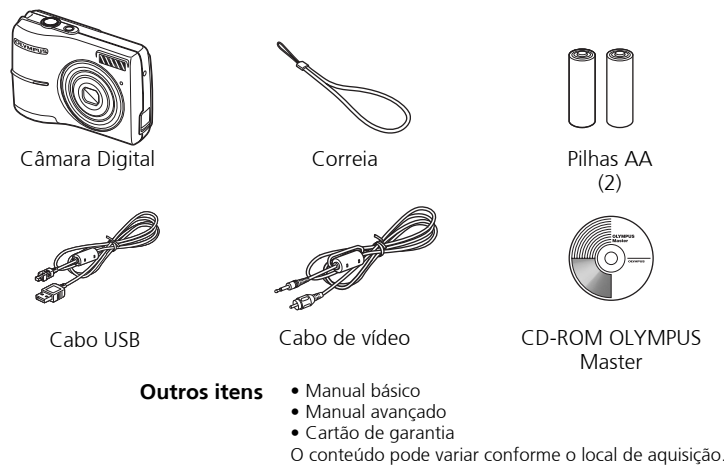

Colocar a correia

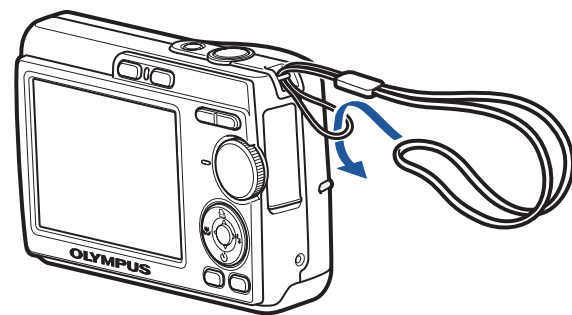

● Puxe bem a correia de modo que não fique frouxa.

2 Inserir as pilhas

a. Insira as pilhas na câmara

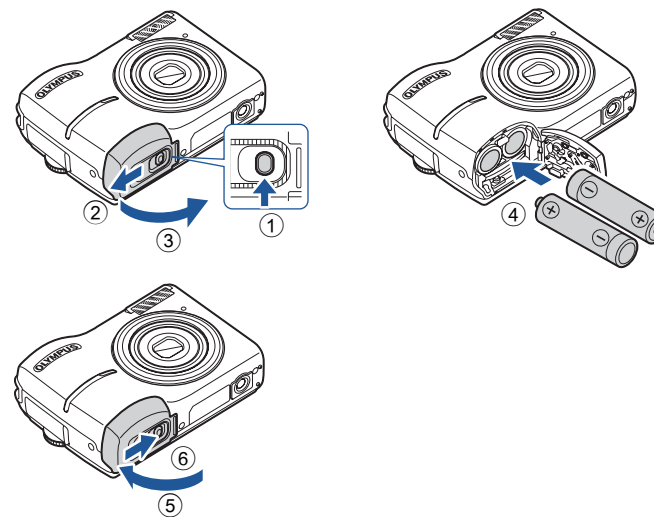

● Quanto aos detalhes sobre a inserção de uma placa xD-Picture Card, consulte o Manual Avançado.

3 Accionar a alimentação

Esta secção explica como activar a câmara no modo fotografia.

a. Ajuste o dial de modo para **AUTO**

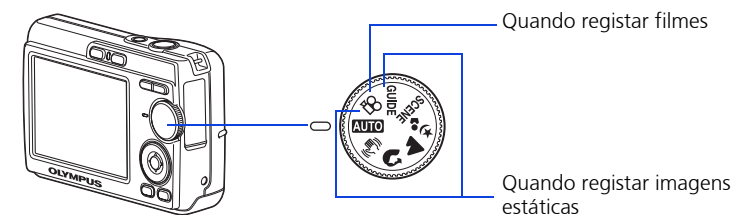

Modos de fotografia de imagem estática

AUTO	A câmara determina as definições óptimas e regista a imagem.
	Esta função reduz a imprecisão causada por um objecto móvel ou movimento da câmara quando fotografar imagens.
	Indicado para fotografar pessoas.
	Indicado para fotografar paisagens.
	Indicado para fotografar pessoas à noite.
SCENE	Selecione um modo de cena para registar imagens de acordo com a situação.
GUIDE	É possível definir os itens desejados, mediante a definição dos parâmetros de acordo com o guia de fotografia exibido no ecrã.

b. Prima o botão **POWER**

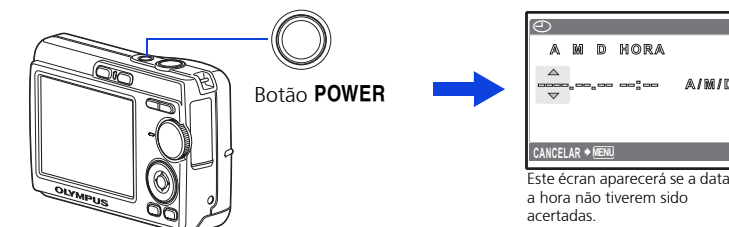

● Para desligar a câmara, prima o botão **POWER** novamente.

4 Acertar data e hora

Acerca do ecrã de acerto da data e da hora

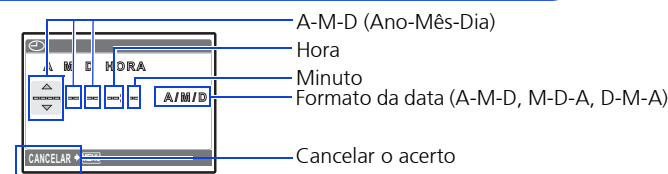

a. Prima o botão and the button para seleccionar [A].

● Os primeiros dois dígitos do ano são fixados.

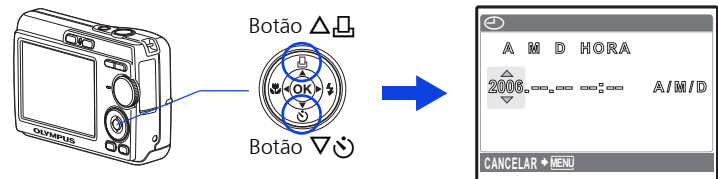

b. Prima o botão

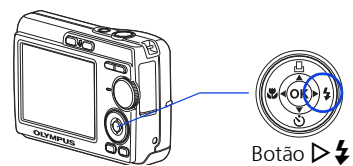

c. Prima o botão and the button para seleccionar [M].



d. Prima o botão . e. Prima o botão and the button para seleccionar [D].



f. Prima o botão . g. Prima o botão and the button para seleccionar "hora" e "minuto".



h. Prima o botão . i. Prima o botão and the button para seleccionar ano, mês e dia.



j. Após todos os parâmetros terem sido definidos, prima .

- A hora é exibida no formato de 24 horas.
- Para uma definição mais precisa, pode-se premir quando o sinal de hora chegar aos 00 segundos.

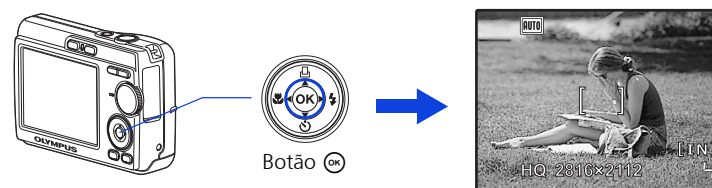

5 Fotografar

a. Segurar a câmara



b. Focar

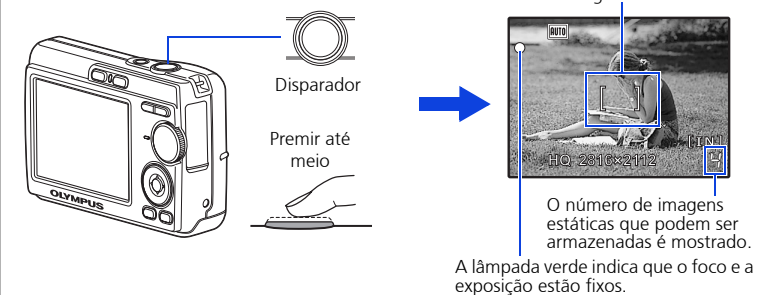

c. Fotografar

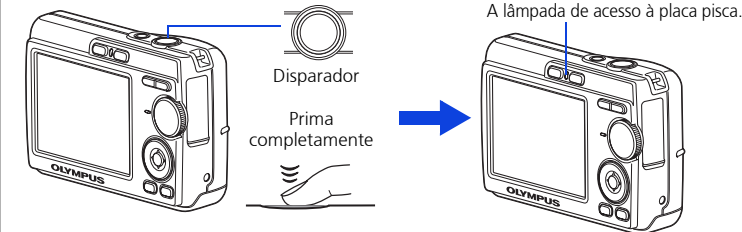

6 Contemplar as fotos

a. Prima o botão

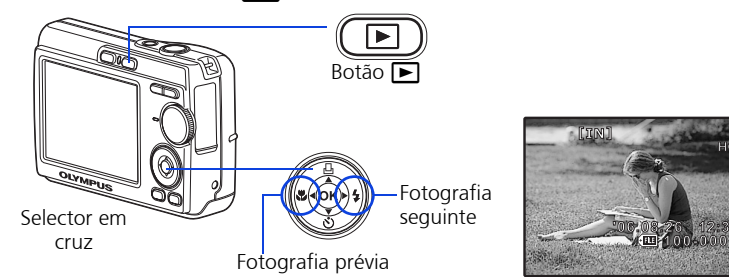

Apagar imagens

a. Conforme descrito acima, exiba a imagem que deseja apagar.

b. Prima o botão .

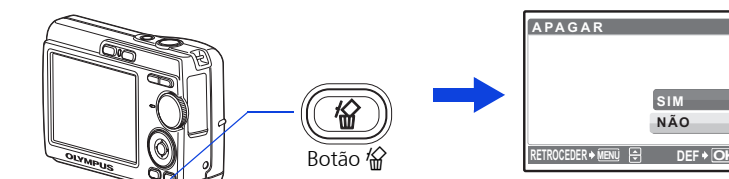

c. Prima o botão para seleccionar [SIM] e então prima .

